



Tools to Navigate Life's Terrain™

Land of ENOUGH Activity Kit

How to Use Gratitude and Stay in ENOUGH Worksheets

Word Finder

Finger Puppets

Coloring Sheets

Yabbut Stuff

Guide to Using the Power of Gratitude

Awesomeness Certificate



Land^{of} Enough

Guide to Using the Power of Gratitude

Here are some tools from your travels through Land of Enough
to help you remember the power of gratitude.



In this Land you will find there's no need for more stuff
Because gratitude shows you there's always Enough.



- Just Not Enough -



**“If you shift your perspective, and stop your assuming
That it’s not enough, it might begin blooming.”**

It’s so easy to forget about what we already have. To look around and not see what we think is enough. But, what is “enough” anyway? What are you wanting or think you are missing?

Instead of focusing on the things you think you are lacking, take a good look around you, at what is right here. What can you appreciate in this moment? What are some simple things that you have right now that maybe you were overlooking?

See the value in the simple things, appreciate what is already around you. When you do, you will see them in a new way.

- Just Not Enough -

Activity

What can you find, right around you, to be grateful for?

Can you think of other things that maybe you missed, or overlooked? Can you see something in a different way than you did before?

The Enough Yabbut & Kid

When you find yourself wanting more, or thinking there isn't enough, remember us and appreciate all that you have around you, at this moment.





- You Have Enough -

“If you’re not happy now, more won’t do any good,
‘Cuz more doesn’t bring joy; never did, never could.”

We can get so focused on wanting MORE that don’t appreciate what we have now. More isn’t a place we can ever get to. Once you get what you wanted, you start wanting more.

Instead of looking for more, trying to get something different or new, think about what you have. How many of the things that you have now were things you once wanted? What are the things in your life that you wanted in the past and then actually got them?

Be grateful for all that you actually have now because **You HAVE Enough.**

- You Have Enough -

Activity

List the things that you have now that you once wanted. Take some time and appreciate them.

Now, list the “more” that you are wanting.

Do you really need it? Is it necessary for you to be happy?



- There IS Enough -

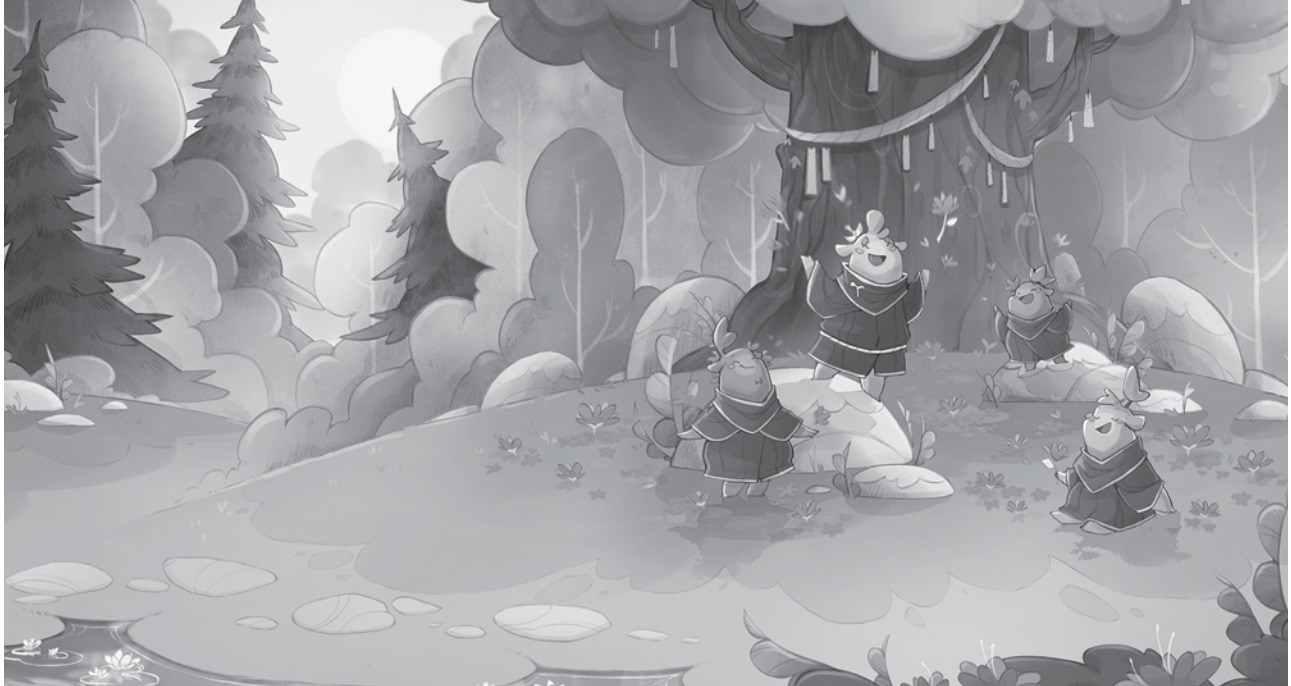

**“It’s only through sharing that you can discover
The joy and connection found giving to others.”**

It can be easy to hang on to and not share the things we have, especially if it’s something we really wanted or think we will run out of. But, sharing with others has a very powerful effect: when you are grateful for what you have, you see that there is plenty to share.

Sharing with others really shows you that maybe you don’t need as much as you thought, and that sharing helps you appreciate what you have. This act of gratitude helps your enough to grow and you see that **There IS Enough**.

- There IS Enough -

Activity

What are some of the many things you can share with others? This can include your time, or something you have that you know another would appreciate.

New Friends

When you share with others, you bring more new friends into your life. And you show others that you care about them.





- You Are Enough -



**“When you’re grateful for you, you will easily see
That YOU are Enough as you are, here with me.”**

Don’t forget to be truly grateful for who you are. The world needs more people who are their authentic selves, not trying to be like everyone else. Plus, only you can be you, and the world needs YOU, as you are.

When you appreciate your real self, and are grateful for all the wonderful things that make you truly unique, then you will see that You ARE ENOUGH.

- You Are Enough -

Activity

List some of the great things about you. Then, write down all of the wonderful, unique things that only you bring to the world.

Ducky & Frog

These two special creatures are here in Enough to show you the Enough you have been longing for and wanting to be.





- Always In Enough -



“Land of Enough was always like this.
But because you weren’t grateful, you easily missed
All the great things you have. So please look, they exist!”

Being grateful and appreciating what you already have, who you truly are, and how you can share it all transforms everything into **ENOUGH**. The world around us can look so different, and better, when we look at it through grateful eyes.

Keep reminding yourself of what makes you special and unique, and appreciate it. Share when you can because it shows such gratitude for what you have. And finally, be grateful for everything and you will always be in **Land of ENOUGH**.

- Always In Enough -

Activity

List all the things you are now grateful for that maybe you didn't appreciate or notice before.

The Flower

Staying in Enough is as simple as being grateful for something as simple as this little flower.





- The Power of Enough -



“Appreciation, my friend, can easily shift
Your enough... to Enough. It is such a great gift.

But it’s something that you’ll need to practice and use
So you’ll make it a habit that you’ll never lose.

To stay in Enough, apply gratitude’s power,
And be grateful for everything, even this flower.”

- The Power of Enough -

Activity

Gratitude has the power to make your life so much better, happier, and fulfilled. All you simply need to do is think of a few things every day that you are grateful for. What are you grateful for today?

- Daily Gratitude List -

Sunday: _____

Monday: _____

Tuesday: _____

Wednesday: _____

Thursday: _____

Friday: _____

Saturday: _____



Land^{of} Enough

Word Finder

How many words can you find from Land of Enough

G N I V I G N B E A N Q Z A D P P A N I
 I J G X S G E N U I N E F J A B U K I G
 N P N S P L K N I O N U V Y X X Z P H K
 E I Q S E O A M E R U N Q U C J I Y T O
 B W F C C S I U U R B R T B A R B O I P
 G R P U I Z J W T G O X V L B P R F W W
 R N E V A I P I G H F S D V T S H Q E T
 A N C R L V A P P R E C I A T I O N E B
 T C R O C F W M O R E N A T B V X V D Z
 E D C O Y Y Y E J U H N T O Y Y G Z U T
 F L P J A A Y L E N O L O I F Y U R T J
 U R P S B F H F Z V N T R U C U G G I I
 L D A P P R E C I A T E U S G B X N T Y
 U I P I V Z T R Y L W O X B U H R I A A
 K H O P Y G H D O O T R P N B E A R R V
 V N G A O K V L L H E W M I W A E A G H
 C U N I Q U E F P W I X S A U M Y H W D
 T E T W D M Z F O A W F R W Y A U S Y F
 Z K N P H A P P Y H J D R G G M N H O N
 E G W H T H A N K F U L F W A E Q F K F

GRATITUDE
 FLOWER
 SHARING
 APPRECIATE
 REWARD
 GENUINE
 SPECIAL

GRATEFUL
 ENOUGH
 POWER
 HAPPY
 LONELY
 AUTHENTIC
 WITHIN

YABBIT
 THANKFUL
 MORE
 GIVING
 GENEROSITY
 UNIQUE
 APPRECIATION

Land of Enough

Word Finder Key

G N I V I G N B E A N Q Z A D P P A N I
I J G X S G E N U I N E F J A B U K I G
N P N S P L K N I O N U V Y X X Z P H K
E I Q S E O A M E R U N Q U C J I Y T O
B W F C C S I U U R B R T B A R B O I P
G R P U I Z J W T G O X V L B P R F W W
R N E V A I P I G H F S D V T S H Q E T
A N C R L V A P P R E C I A T I O N E B
T C R O C F W M O R E N A T B V X V D Z
E D C O Y Y Y E J U H N T O Y Y G Z U T
F L P J A A Y L E N O L O I F Y U R T J
U R P S B F H F Z V N T R U C U G G I I
L D A P P R E C I A T E U S G B X N T Y
U I P I V Z T R Y L W O X B U H R I A A
K H O P Y G H D O O T R P N B E A R R V
V N G A O K V L L H E W M I W A E A G H
C U N I Q U E F P W I X S A U M Y H W D
T E T W D M Z F O A W F R W Y A U S Y F
Z K N P H A P P Y H J D R G G M N H O N
E G W H T H A N K F U L F W A E Q F K F

GRATITUDE
FLOWER
SHARING
APPRECIATE
REWARD
GENUINE
SPECIAL

GRATEFUL
ENOUGH
POWER
HAPPY
LONELY
AUTHENTIC
WITHIN

YABBUT
THANKFUL
MORE
GIVING
GENEROSITY
UNIQUE
APPRECIATION



Land of Enough Finger Puppets!!!

To make these fun puppets, just follow these simple steps.

You will need:



CRAYONS



SCISSORS



TAPE

1 Print this PDF.

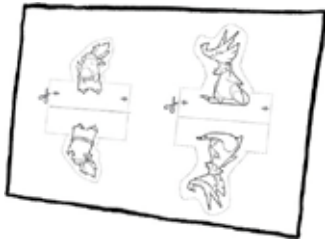

2 Color the puppets.



3 Cut along the dashed lines to cut out the puppets.

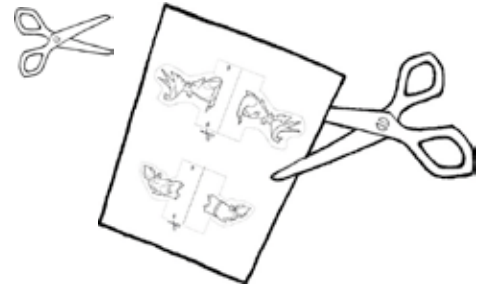

4 Fold each puppet in half along the black solid line.



5 Cut along the dotted lines.

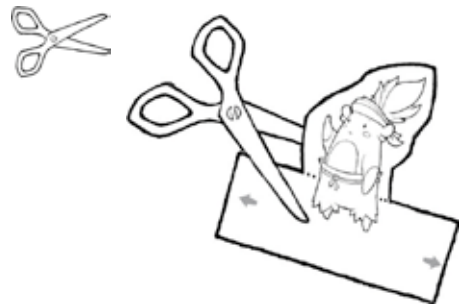

6 Roll the bottom into a tube so that the arrows touch; then tape it together. It should be a little bit bigger than your finger.

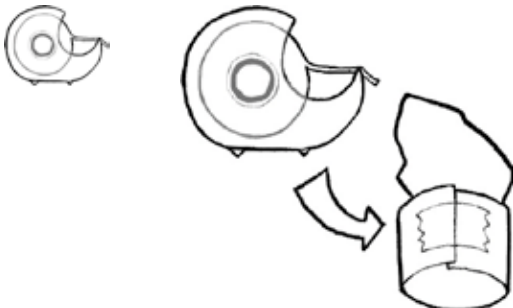

7 Hooray! You just made finger puppets!

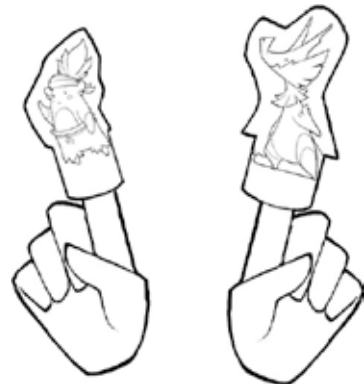

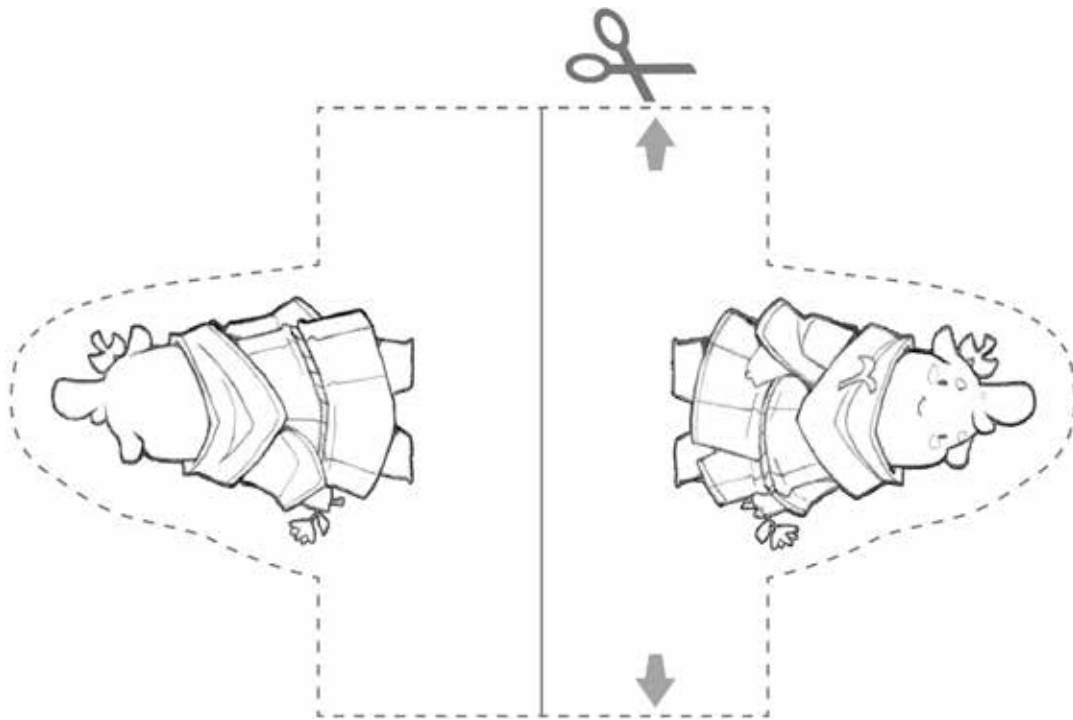

The Kid - YOU in Land of Enough

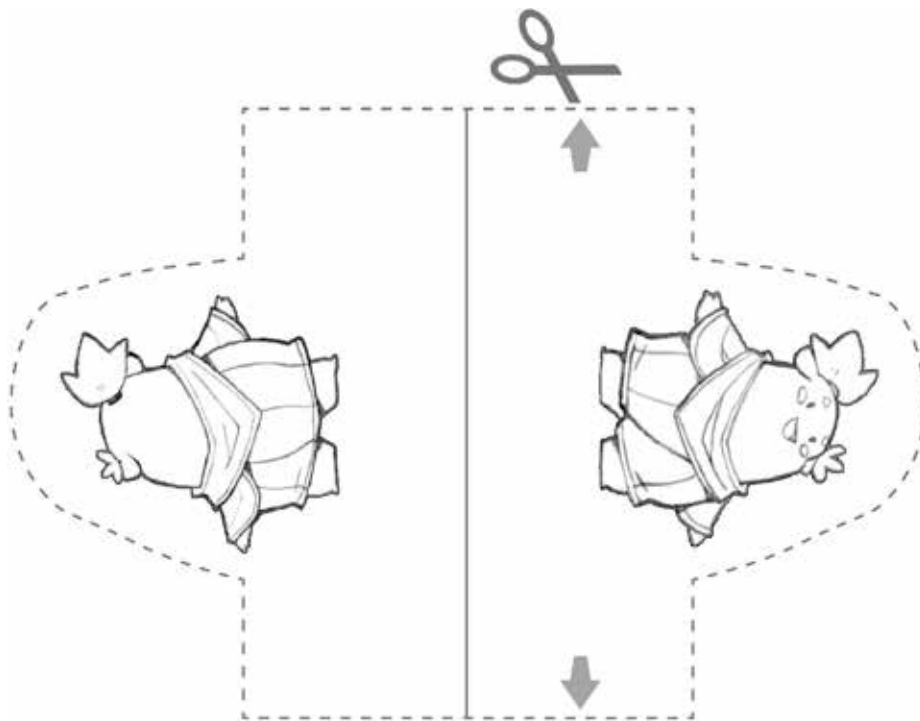

New Friend in Enough

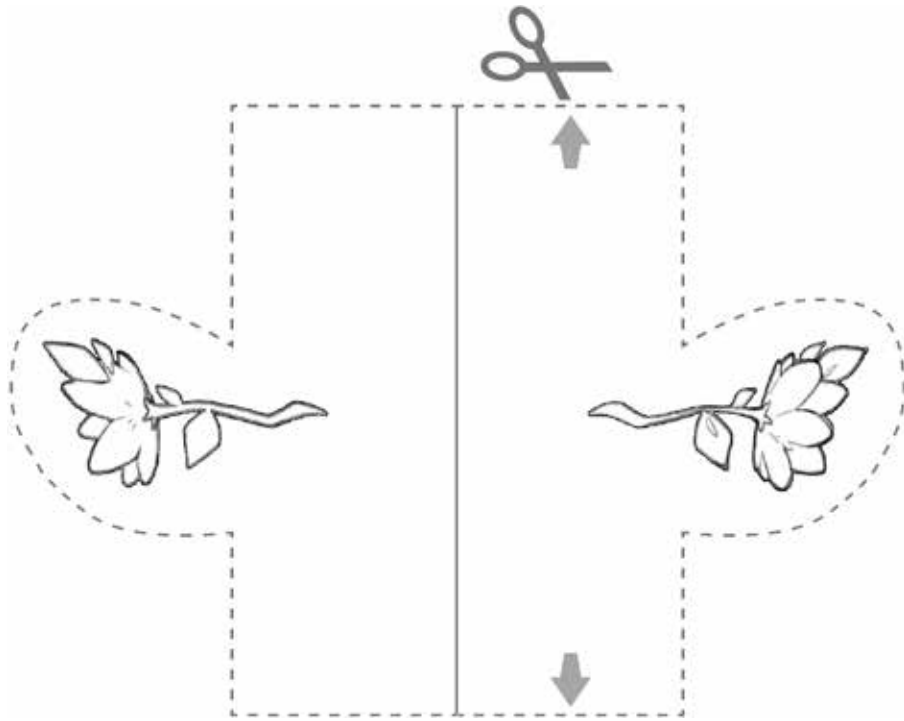

The Enough Flower

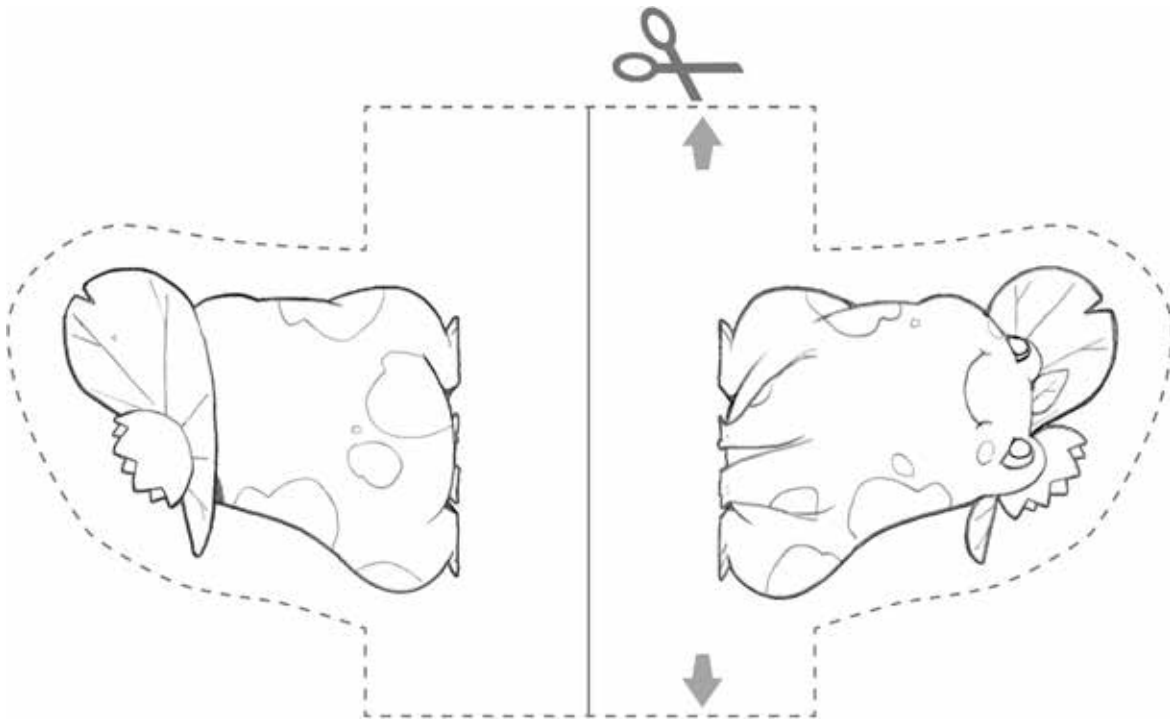

Froggie Friend

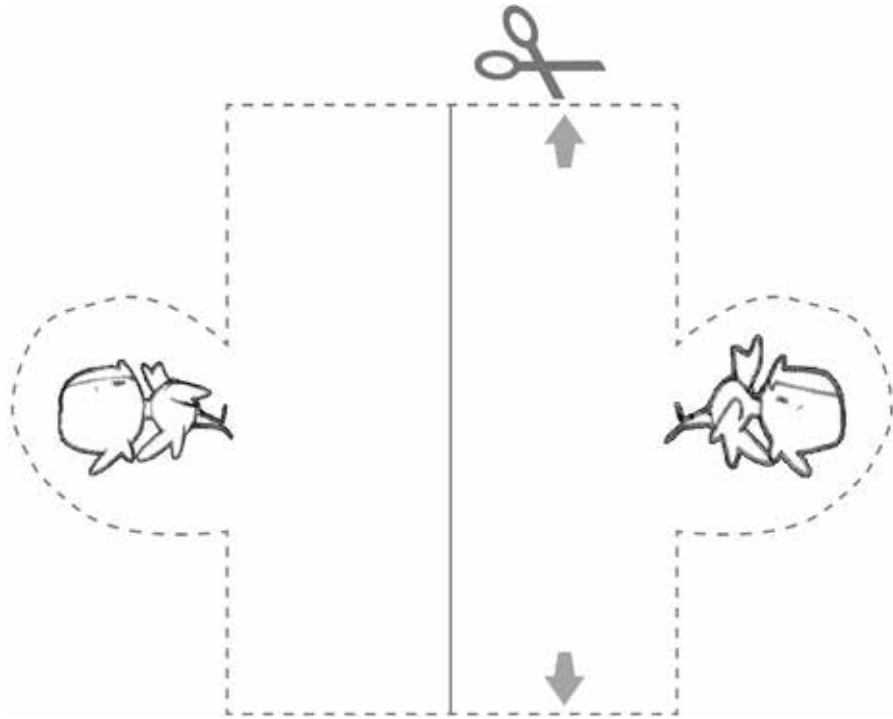

The Ducky who points out Enough

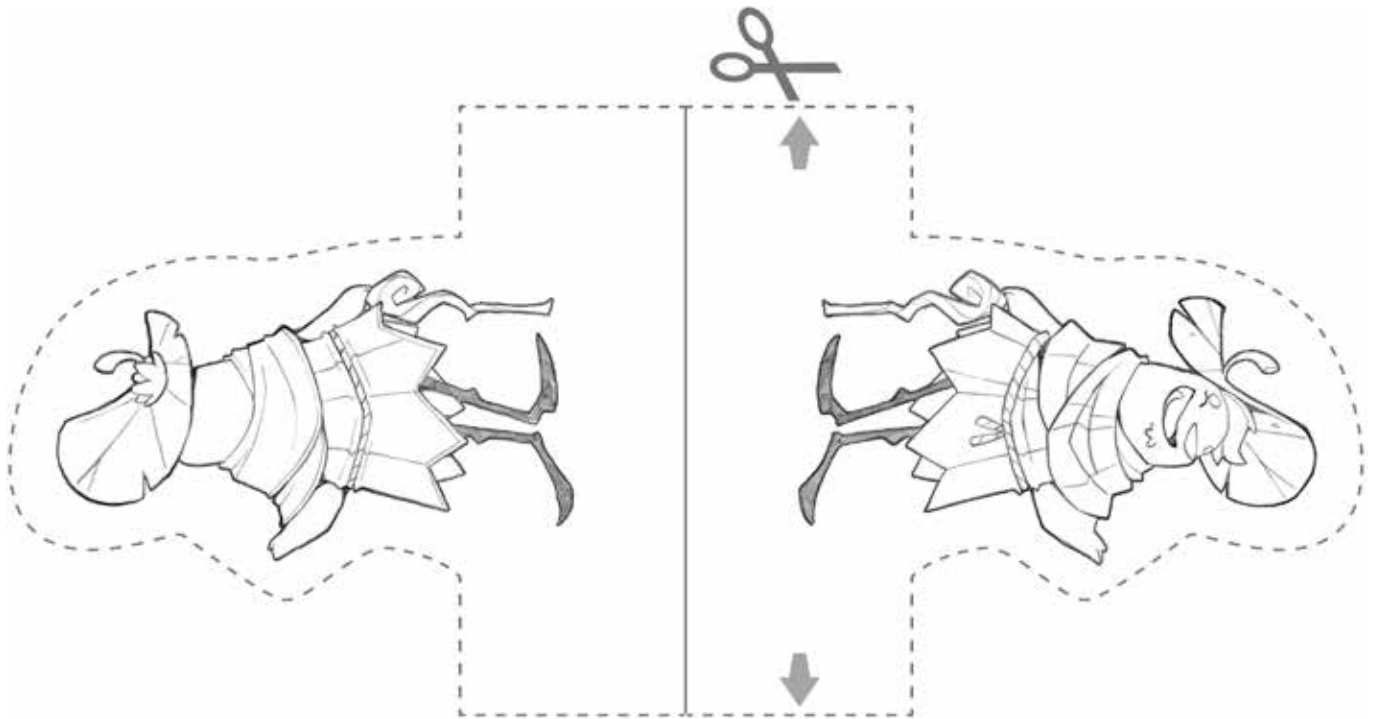

The Yabbut, Your Guide to Enough

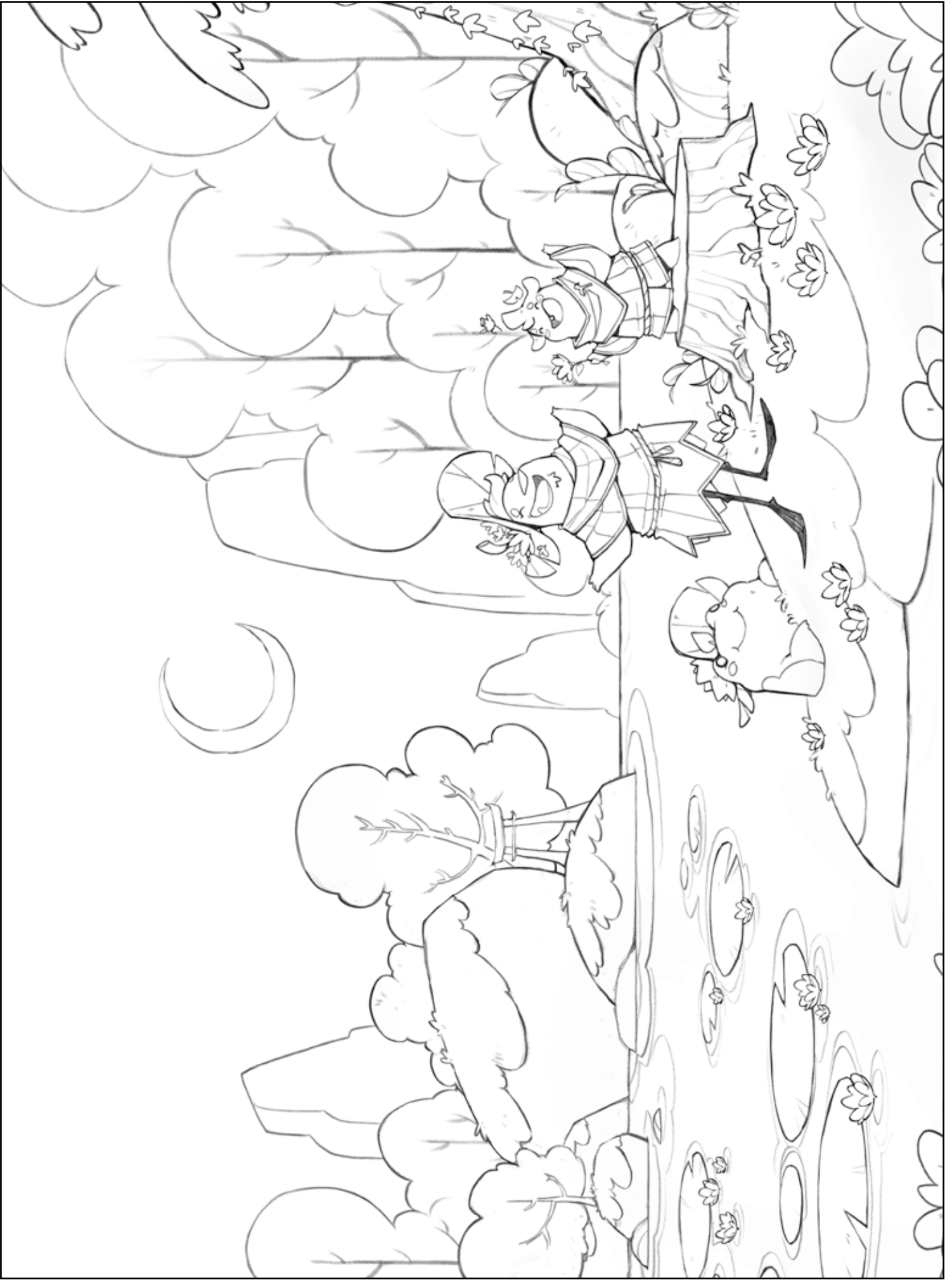

the Yabbut®

The Yabbut you see, it has only one use;
to always be near and provide an excuse.

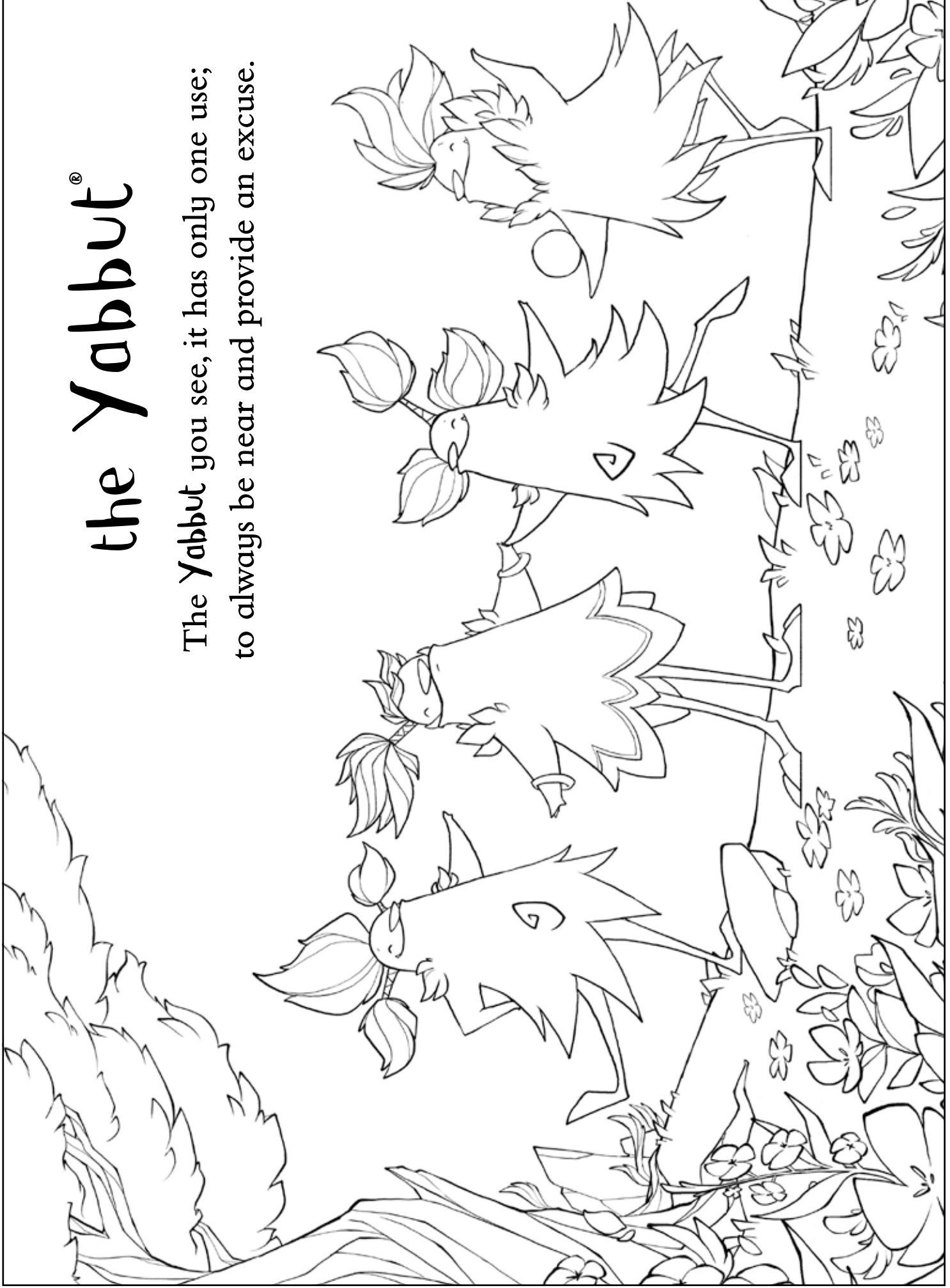

the Yabbut®

Land of Enough



Land^{of} Enough

Guide to Using the Power of Gratitude

1. Appreciate the small things that are around you right now. You will see them in a new way.
2. Instead of looking for More, be grateful for what you have now, because you have Enough.
3. When you share, instead of keeping it all to yourself, it shows gratitude for what you have. And you will see that there is Enough.
4. When you appreciate who you truly are, you will see that you are Enough.
5. Once you can truly be grateful for all that you have and all that you are, your world changes and you see that you can always be in Enough.

Listen to your guide, the Yabbut!



From your friends in
Land of Enough.



The Yabbut



Certificate of Awesomeness

Is Presented To: _____

for showing gratitude and appreciation!
And for using the lessons in Land of Enough to be grateful!

Date: _____ Presented By: _____

We salute you for your commitment to gratitude
and for remembering the lessons in Land of Enough.

Katie Mullaly, Author



Toby Allen, Illustrator